

VAD 3C-4-1
0°

Sensor-Anschlussleitung, Steckverbinder für Druckschalter nach DIN EN 175301-803, Bauform A, mit LED-Betriebs- und Funktionsanzeige

Sensor cordset, single-ended, connector for pressure switch- es, according to DIN EN 175301-803, form A, with LED operation and function indica- tor

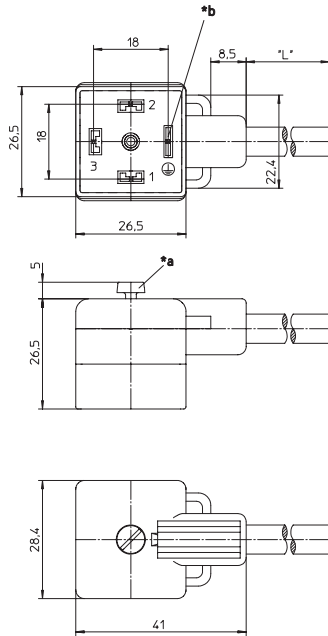

*a M3-Schraube
M3 screw
*b Kabelabgang 0°
cable exit 0°

VAD 3C-4-2
180°

Sensor-Anschlussleitung, Steckverbinder für Druckschalter nach DIN EN 175301-803, Bauform A, mit LED-Betriebs- und Funktionsanzeige, Kabelabgang 180°

Sensor cordset, single-ended, connector for pressure switch- es, according to DIN EN 175301-803, form A, with LED operation and function indica- tor, cable exit 180°

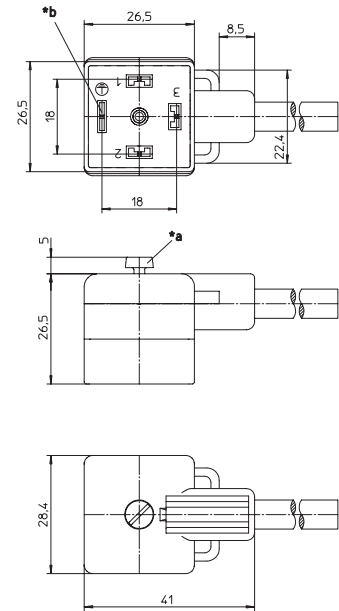

*a M3-Schraube
M3 screw
*b Kabelabgang 180°
cable exit 180°



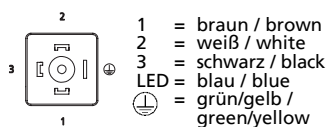
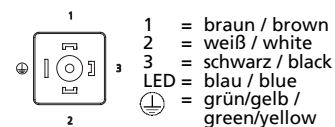

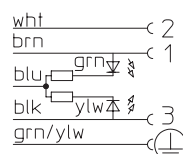
Pinbelegung
Pin assignment

VAD 3C-4-1

VAD 3C-4-2

Schaltbild
Wiring diagram

VAD 3C

Anschlussleitungen für Aktoren, Sensoren und Verteiler Cordsets, single-ended, for actuators, sensors and distribution boxes

Technische Daten		Technical data	
Umgebungstemperatur	-25°C / +80°C	Operating temperature range	-25°C / +80°C
Werkstoffe		Materials	
Gehäuse / Griffkörper	TPU, selbstverlöschend	Housing / Molded body	TPU, self-extinguishing
Kontaktträger	PBT	Insert	PBT
Kontakt	CuZn, vernickelt und verzinkt	Contact	CuZn, nickel-plated and tin-plated
Mechanische Daten		Mechanical data	
Schutzart	IP 67 Nur im verschraubten Zustand mit den dazugehörigen Gegenstücken.	Degree of protection	IP 67 Only in locked position with its proper counterparts.
Elektrische Daten		Electrical data	
Durchgangswiderstand	≤ 5 mΩ	Contact resistance	≤ 5 mΩ
Nennstrom bei 40°C	4 A	Nominal current at 40°C	4 A
Nennspannung	24 V DC	Nominal voltage	24 V DC
Bemessungsspannung	32 V	Rated voltage	32 V
Isolationswiderstand	> 10 ⁹ Ω	Insulation resistance	> 10 ⁹ Ω
Verschmutzungsgrad	3	Pollution degree	3
Zubehör (inkl.)	Beschriftungsschild Schraube (montiert)	Accessories (incl.)	Attachable label Screw (fitted)

Bestellbezeichnung Designation		Polzahl Poles	Mantel Outer jacket	
VAD 3C-4-1-228/... M	VAD 3C-4-2-228/... M	3 + ⊕	PUR halogenfrei / halogen free	 
VAD 3C-4-1-259/... M	VAD 3C-4-2-259/... M		PUR halogenfrei / halogen free schweißfunkenfest / welding spark proof	  
Standardlängen: 2 M / 5 M / 10 M Andere Kabellängen oder Leitungsaufbauten auf Anfrage.			Standard lengths: 2 M / 5 M / 10 M Other cable lengths or cable specifications on request.	